

# d-flexx

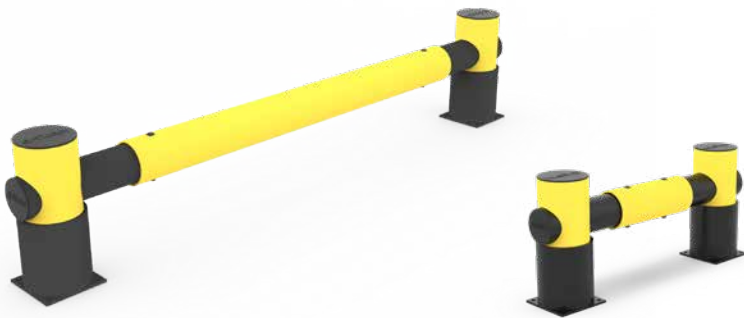

# GOLF

## Racking Protection single rail



### Description

Ensure the safety and longevity of your racking systems with the Racking Protection for GOLF. Engineered for robust performance and maximum impact resistance, this protective solution is ideal for safeguarding your storage infrastructure from potential damage. GOLF Racking Protection is designed to mitigate the risk of collisions and accidental impacts, preserving the integrity and operational efficiency of your racking systems.

GOLF is specifically tailored for use in environments where high-density storage systems are in operation. It is suitable for a variety of industrial settings including warehouses, distribution centres, and retail spaces. This product is particularly effective in areas where forklift and pallet truck traffic are frequent, and where structural integrity of the racking systems is critical.

It is TÜV certified, reflecting our commitment to delivering products that meet rigorous safety and quality standards. The product adheres to PAS13 guidelines, which are designed to ensure the effective protection of racking systems in line with best practices in the industry.

### Technical Information

Operational Temperature Range:	-40°C up to +50°C / -40°F up to +112°F
Ignition Temperature:	350-360°C / 662 - 680°F
Flash Point:	350-360°C / 662 - 680°F
Toxicity:	Nontoxic
Chemical Resistance:	High-ISO / TR 10358
UV Stability	Gray scale: 5/5
Changes to material after 5 years:	Blue Wool scale: 8/8 Tensile strength: No changes
Static Rating (surface resistivity):	10 <sup>15</sup> -10 <sup>16</sup> Ω
Standard Warranty:	5 Years
Fixations:	Concrete screw, Zinc coated, Size Ø12x80 mm
Deflection zone:	250mm / 9,84in

Tested Impact Energy  
according to TÜV

**47.900 Joule**

At 22.5° Impact, 5.4 km/h  
(3,35 mph) and 3.560 kg (7848 lbs)  
on a C20/25 concrete floor and  
max. force to bolt at 21 kN.

Scan or click to review



Maintenance Guide  
Assembly Guide  
Videos  
Tender Text  
Warranty



**Specifications**

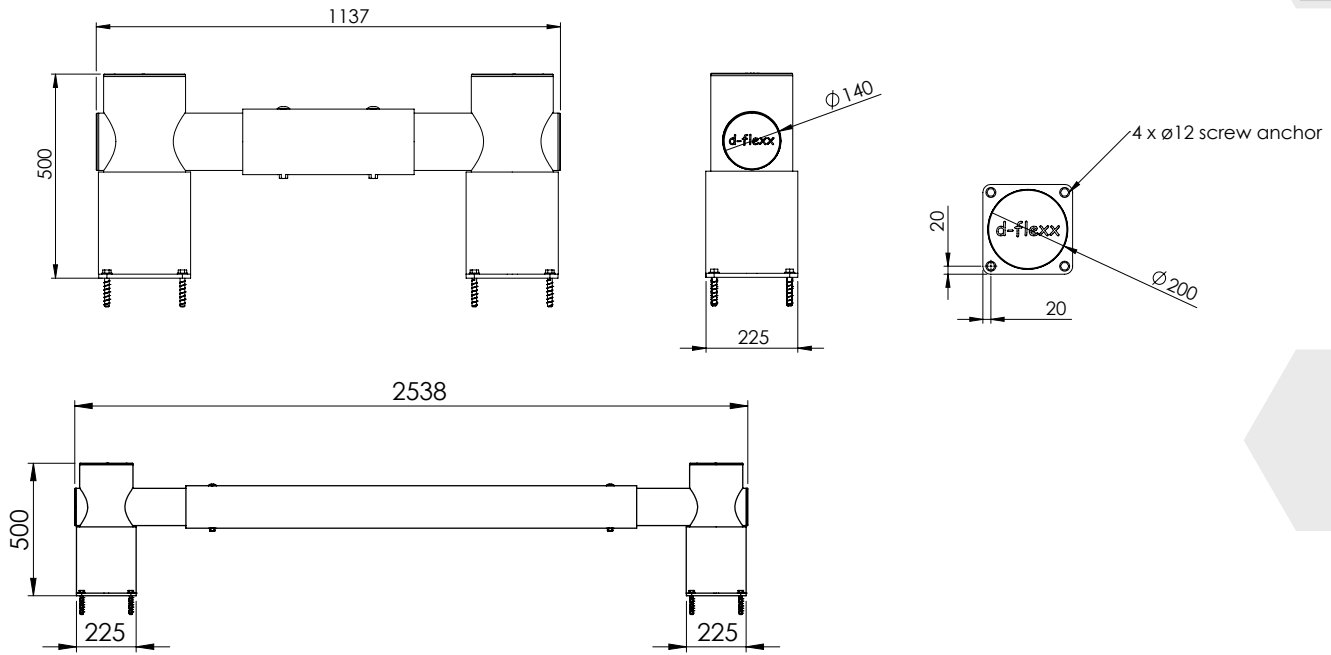

**Measurements mm vs in**

	mm	in
Diameter 1	200	7,87
Diameter 2	140	5,51
Height	500	19,69
Width 1	1137	44,72
Width 2	2538	99,92
Footplate	225	8,86
Pos. drill holes	20	0,79

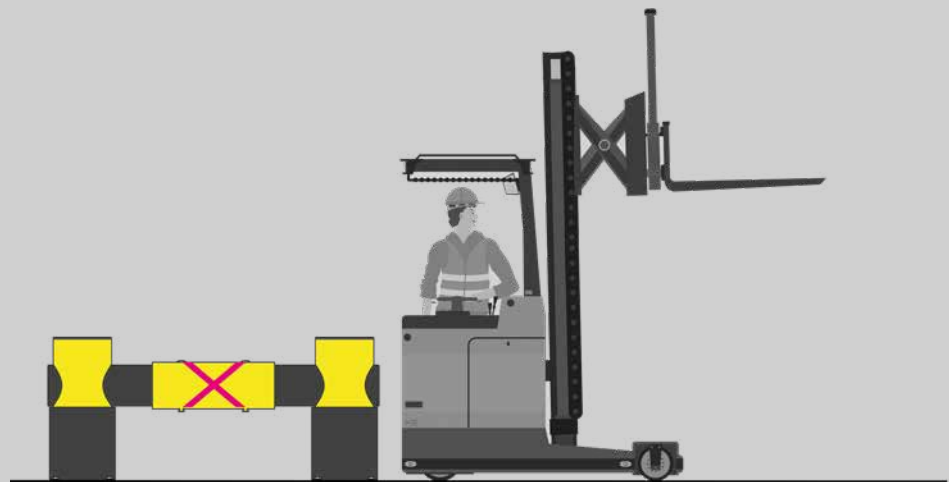

**Max. force to bolt 21 kN**

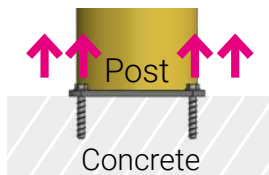

**Impact Test GOLF single rail**

Mid Rail Max. Energy (Joules)	90°	67,5°	45°	22,5°
	7.000	8.200	14.000	47.900

End post max. energy (Joules) - 90° 4.000

# d-flexx



# GOLF

## Racking Protection double rail



### Description

Ensure the safety and longevity of your racking systems with the Racking Protection for GOLF. Engineered for robust performance and maximum impact resistance, this protective solution is ideal for safeguarding your storage infrastructure from potential damage. GOLF Racking Protection is designed to mitigate the risk of collisions and accidental impacts, preserving the integrity and operational efficiency of your racking systems.

GOLF is specifically tailored for use in environments where high-density storage systems are in operation. It is suitable for a variety of industrial settings including warehouses, distribution centres, and retail spaces. This product is particularly effective in areas where forklift and pallet truck traffic are frequent, and where structural integrity of the racking systems is critical.

It is TÜV certified, reflecting our commitment to delivering products that meet rigorous safety and quality standards. The product adheres to PAS13 guidelines, which are designed to ensure the effective protection of racking systems in line with best practices in the industry.

### Technical Information

Operational Temperature Range:	-40°C up to +50°C / -40°F up to +112°F
Ignition Temperature:	350-360°C / 662 - 680°F
Flash Point:	350-360°C / 662 - 680°F
Toxicity:	Nontoxic
Chemical Resistance:	High-ISO / TR 10358
UV Stability	Gray scale: 5/5
Changes to material after 5 years:	Blue Wool scale: 8/8 Tensile strength: No changes
Static Rating (surface resistivity):	10 <sup>15</sup> -10 <sup>16</sup> Ω
Standard Warranty:	5 Years
Fixations:	Concrete screw, Zinc coated, Size Ø12x80 mm
Deflection zone:	250mm / 9,84in

Tested Impact Energy  
according to TÜV

**89.000 Joule**

At 22.5° Impact, 4,9 km/h  
(3,04 mph) and 4.320 kg (9523 lbs)  
on a C20/25 concrete floor and  
max. force to bolt at 21 kN.

Scan or click to review



Maintenance Guide  
Assembly Guide  
Videos  
Tender Text  
Warranty



**Specifications**

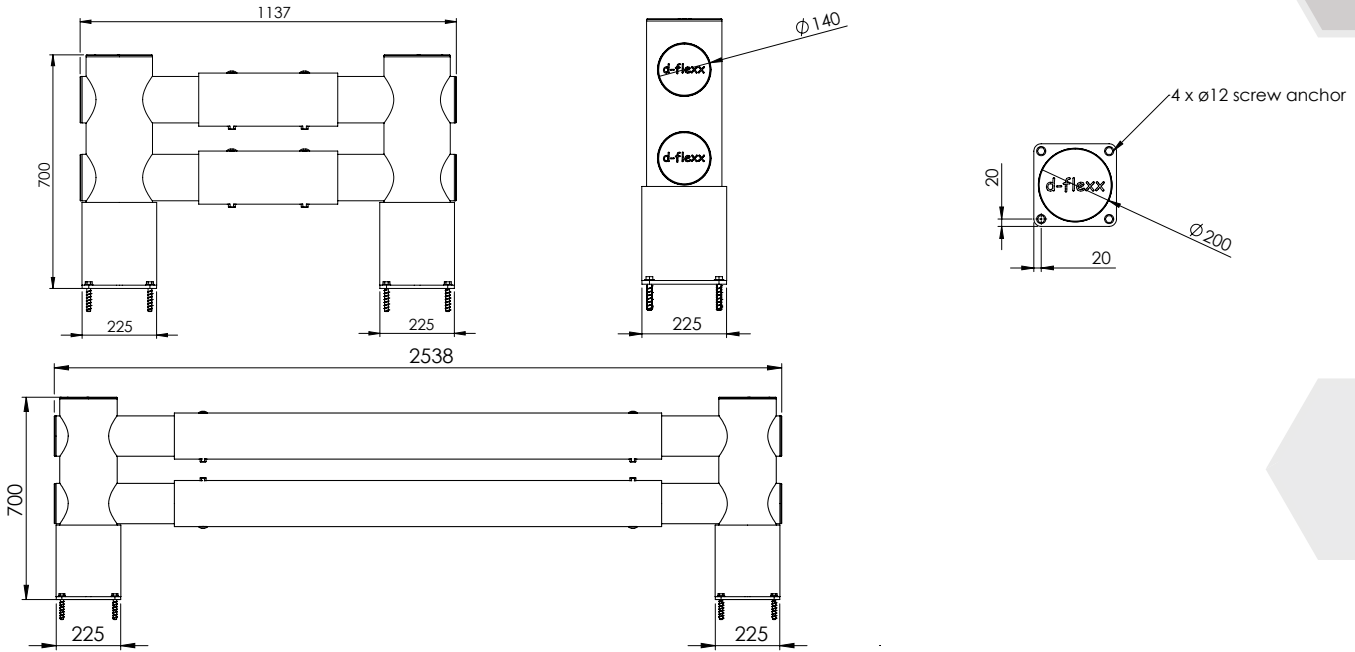

**Measurements mm vs in**

	mm	in
Diameter 1	200	7,87
Diameter 2	140	5,51
Height	700	19,69
Width 1	1137	44,72
Width 2	2538	99,92
Footplate	225	8,86
Pos. drill holes	20	0,79

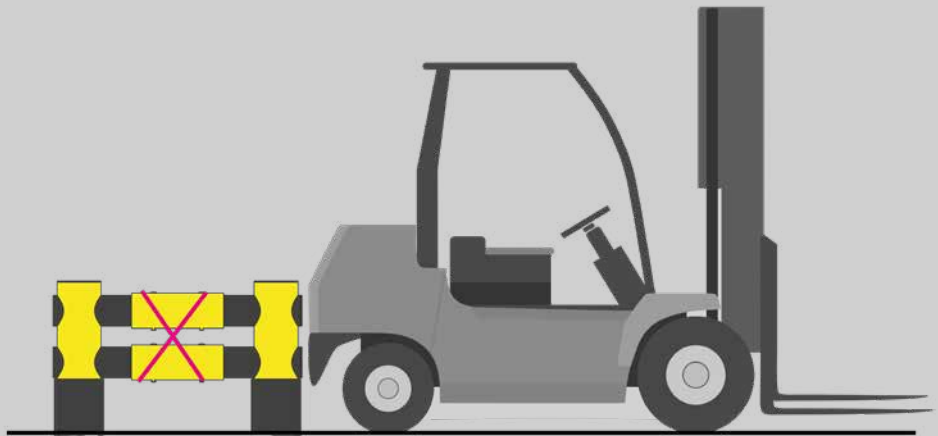

**Max. force to bolt 21 kN**

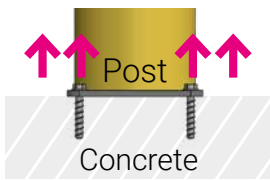

**Impact Test GOLF double rail**

Mid Rail Max. Energy (Joules)	90°	67,5°	45°	22,5°
	13.000	15.200	26.000	89.000
End post max. energy (Joules) - 90°				4.000